

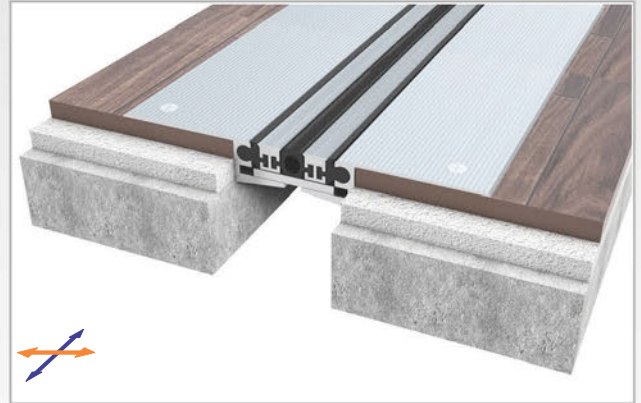

AS U236 surface mounted floor profiles are designed for pedestrian and can easily be applied to all types of floors. Adjustable interlocking profile and gasket configuration makes it available for gaps up to 200 mm and enables to meet horizontal & lateral shear movements. Profiles at H:28 & H:35 mm are manufactured heavy duty. If inquired, AS U236 can be applied with wall type AS U136 and this dual application brings in a decorative aspect. Profiles are delivered factory-assembled.

- Application Areas** : Indoor & Outdoor / Floor
- Ideal for** : Residences, Offices etc.
- Material** : Mill Finish Aluminum (Anodizing optional), TPE Gasket
- Aluminum Alloy** : 6063 AA-USA / EN AW 6063
- Optional Supplies** : Fire Barrier, Waterproof EPDM membrane

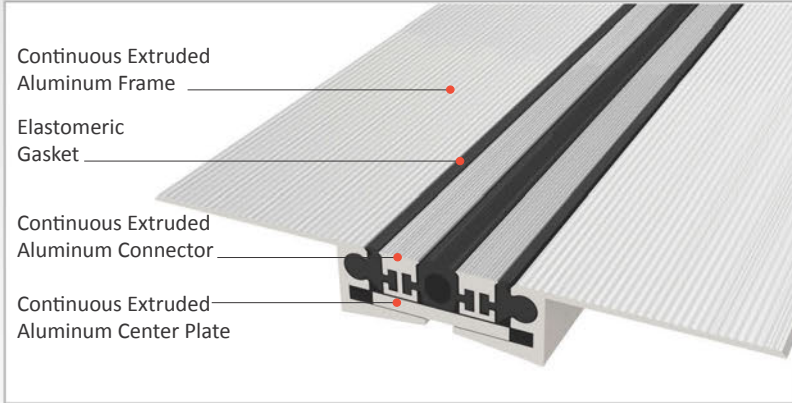

FLOOR

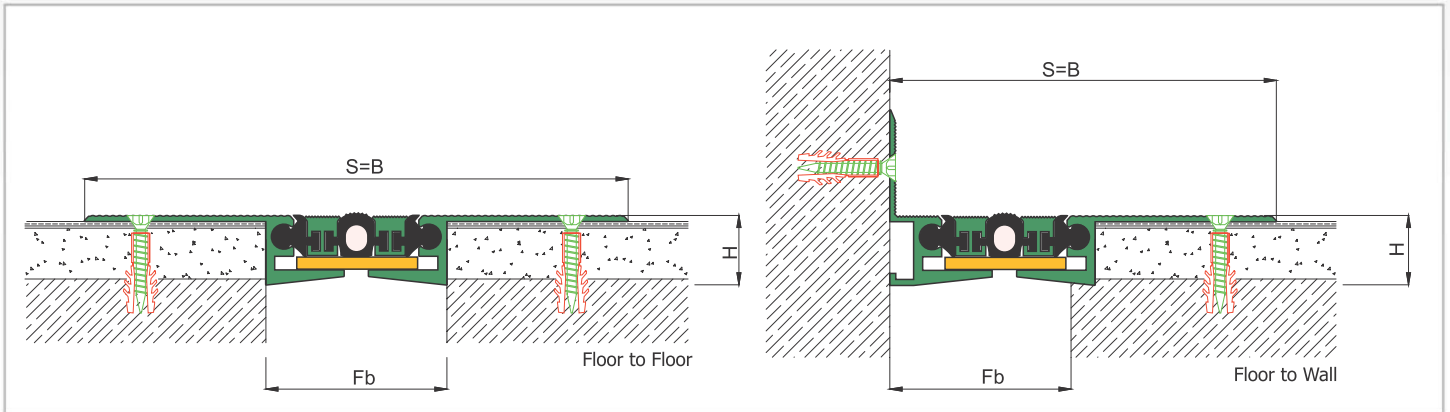

* Visuals are representative and the profile configuration may differ depending on the characteristics requested.



LOCATION	MODEL	GAP (Fb) mm	HEIGHT (H) MM	OVERALL WIDTH (B) mm	VISIBLE WIDTH (S) mm	MOVEMENT (W) mm	LOAD CAPACITY	STANDARD LENGTH (mt)
Floor to Floor	AS U236-035	35	15	155	155	± 2		3
	AS U236-060	60	23	180	180	± 4		3
	AS U236-080	80	23	200	200	± 6		3
	AS U236-100	100	23	220	220	± 8		3
	AS U236-120	120	23	240	240	± 10		3
	AS U236-140	140	24	260	260	± 12		3
	AS U236-160	160	24	280	280	± 14		3
	AS U236-180	180	24	300	300	± 16		3
	AS U236-200	200	24	320	320	± 18		3

Note: Please ask for different sizes

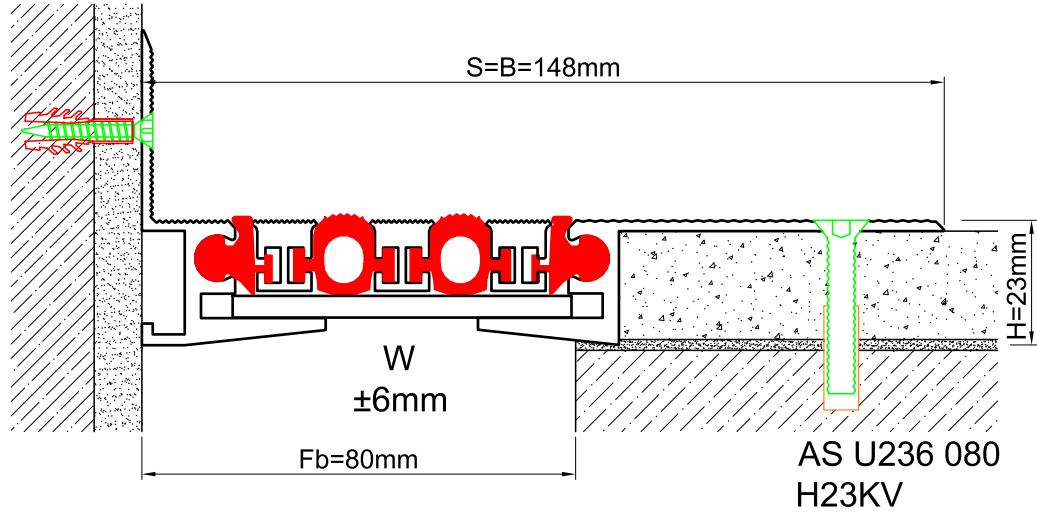
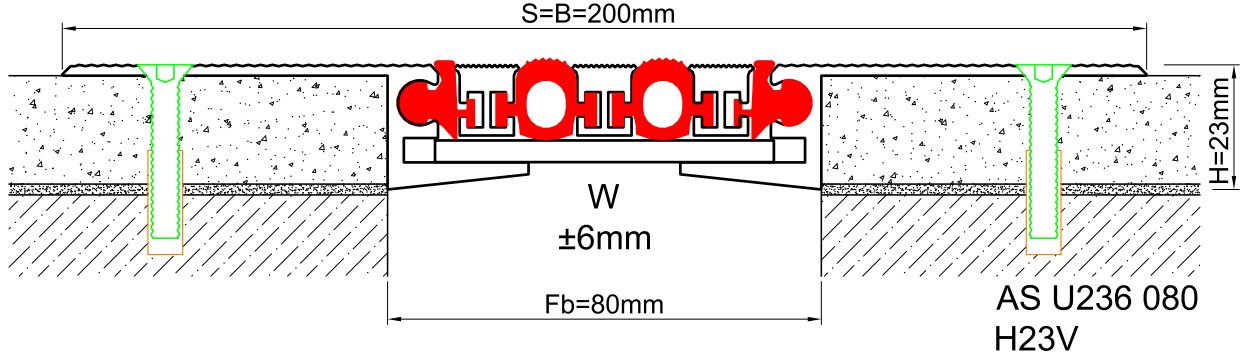

Profil No Profile Number	AS U236 080	AS U236 080K
Fb (mm)	80	80
H (mm) yaklaşık approx.	23	23
W± (mm) yaklaşık approx.	±6	±6
Renk Color	Alüminyum: Natürel, Fitiller: Siyah, gri, diğer Aluminum: Natural, Inserts: Black, grey, others	
Malzeme Material	Alüminyum, Termoplastik Kauçuk (gri ve diğer) Aluminum, Thermoplastic Rubber (grey and others)	
Standart Uzunluk Standard Length	3	
Yükleme Kapasitesi Load-Bearing Capacity	